





spaceframes

8 domestic fragments

Fabricated as an installation in the Locker Plant Gallery during an artist-in-residency at Donald Judd's Chinati Foundation in Marfa, Texas - these eight spaceframes create experience. Employing architectural fragments: hollow core doors, laminated 2x4s, and door peep-holes each composition employs a choreographed view (orchestrated by the viewfinder) through a three-dimensional architectural fragment, arriving at the two-dimensional shallow projected composition.

The eight spaceframes investigate a variety of fragments from domestic life: entry, conversation, work, store, watch, eat, bathe, sleep. Each of the fragments is intended to be viewed alone and then stitched together through the sightline. Exploring the spatial and phenomenological aspects of these components each piece isolates to precisely articulate its identity.

A process sketchbook accompanies each of the spaceframes. It contains conceptual, developmental and fabrication drawings that aid in the interpolation of the installation. The fabrication is not a representation of experience but the experience itself.





[anatomy of a spaceframe]

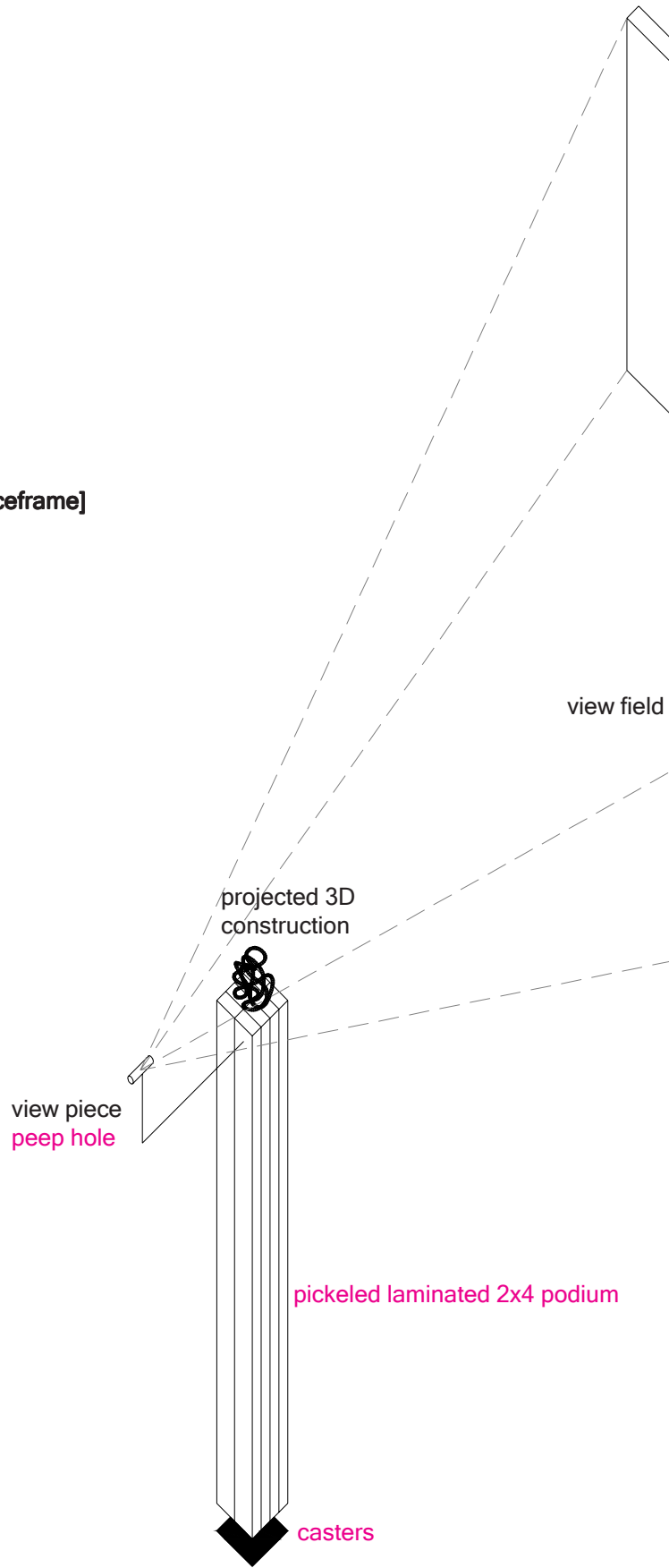

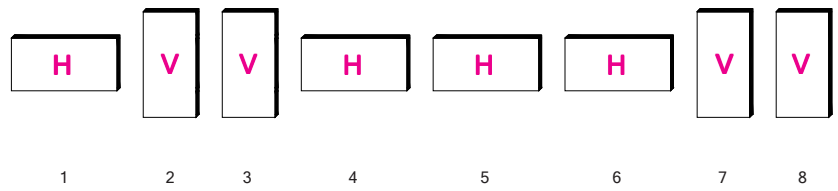
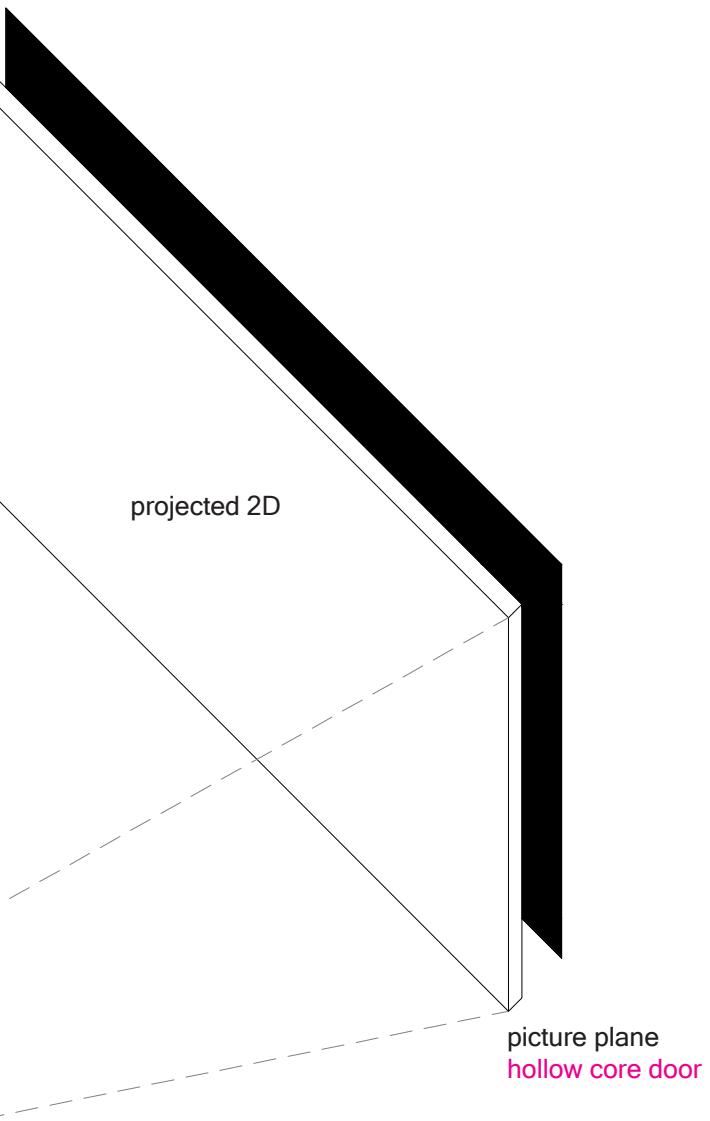



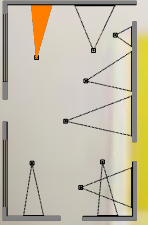

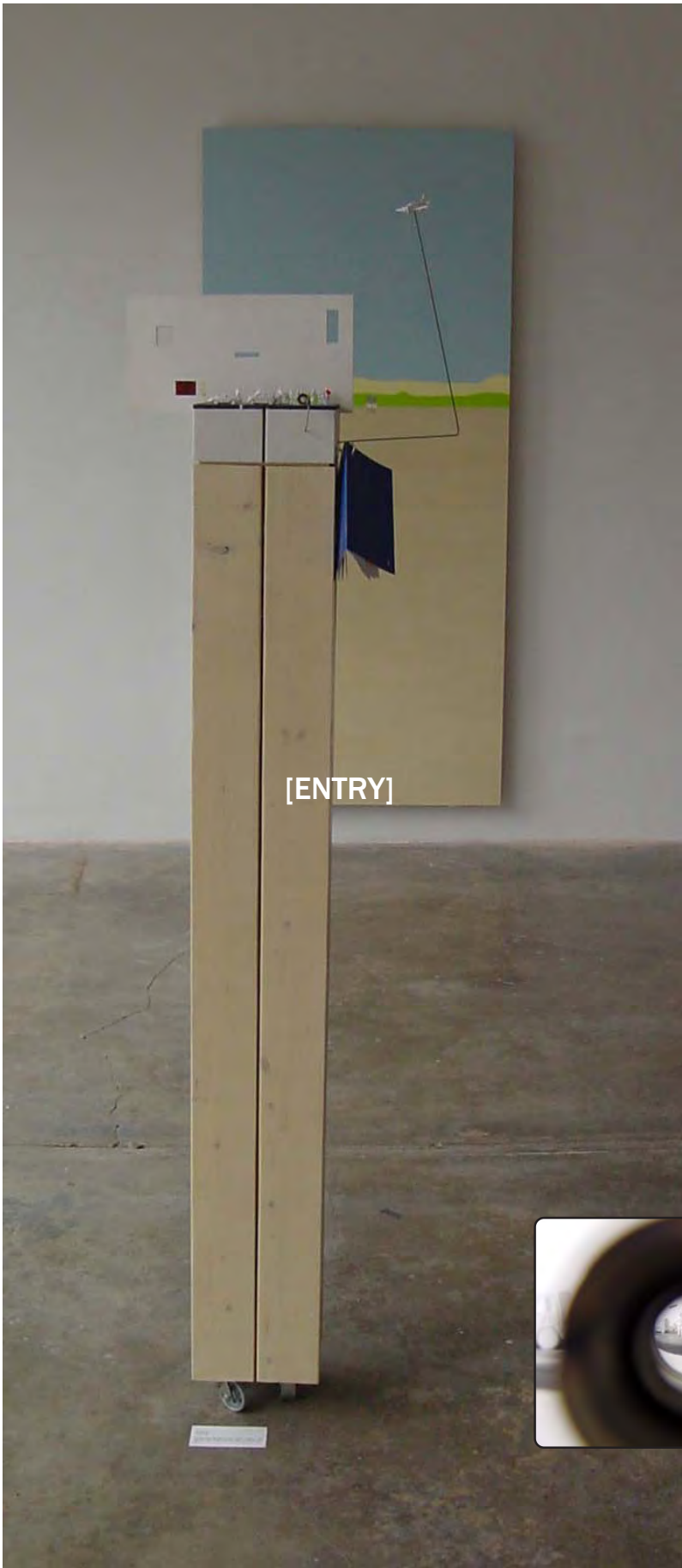

[ENTRY]



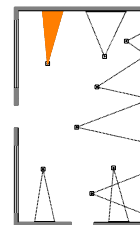

The threshold of entry collapses space from the massive line of the horizon to the microcosmic world of a constructed interior. Mediated by a parking field, the view chamber siphons from the collective group to the individual. The figure is used to provide scale, but abandoned in all other spaceframes. Distance and dimension become relative to the composition requiring the projection of the viewer to determine scale. The view port layers the foreground against the background with a large wall. The planar separation allows multiple funnel views to fragments of sky, earth, horizon, and all three together.

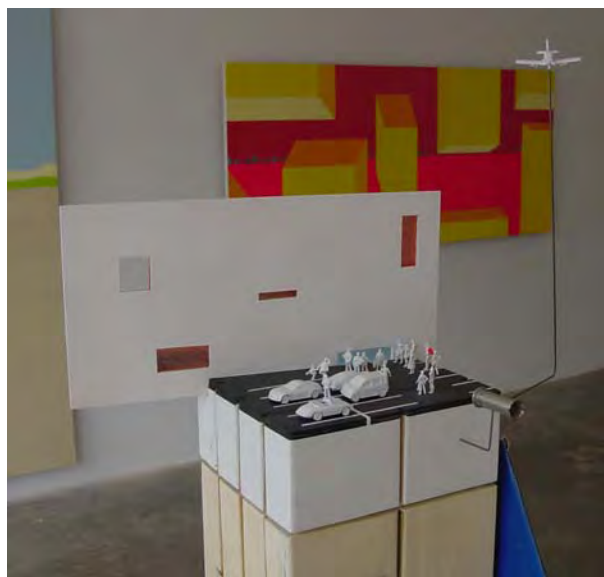
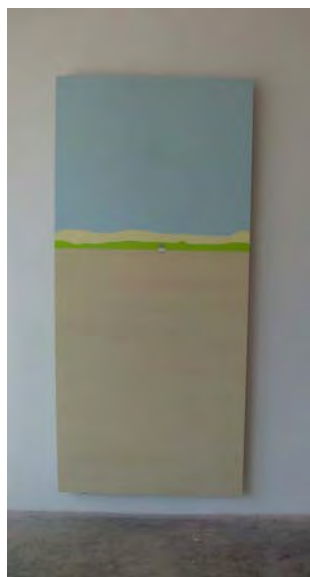
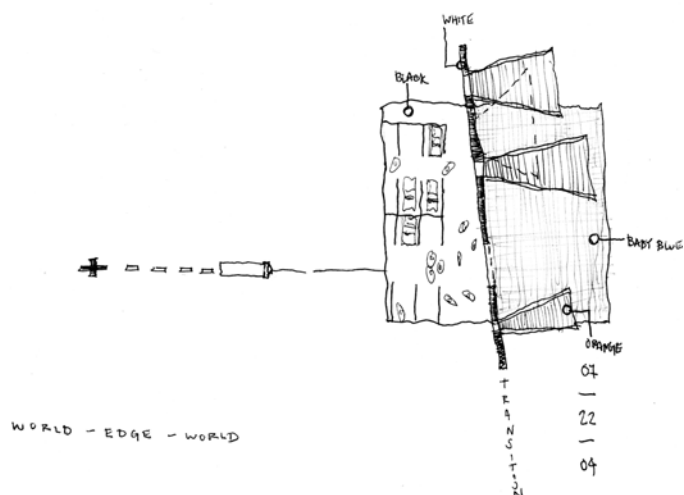



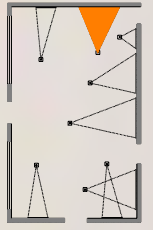

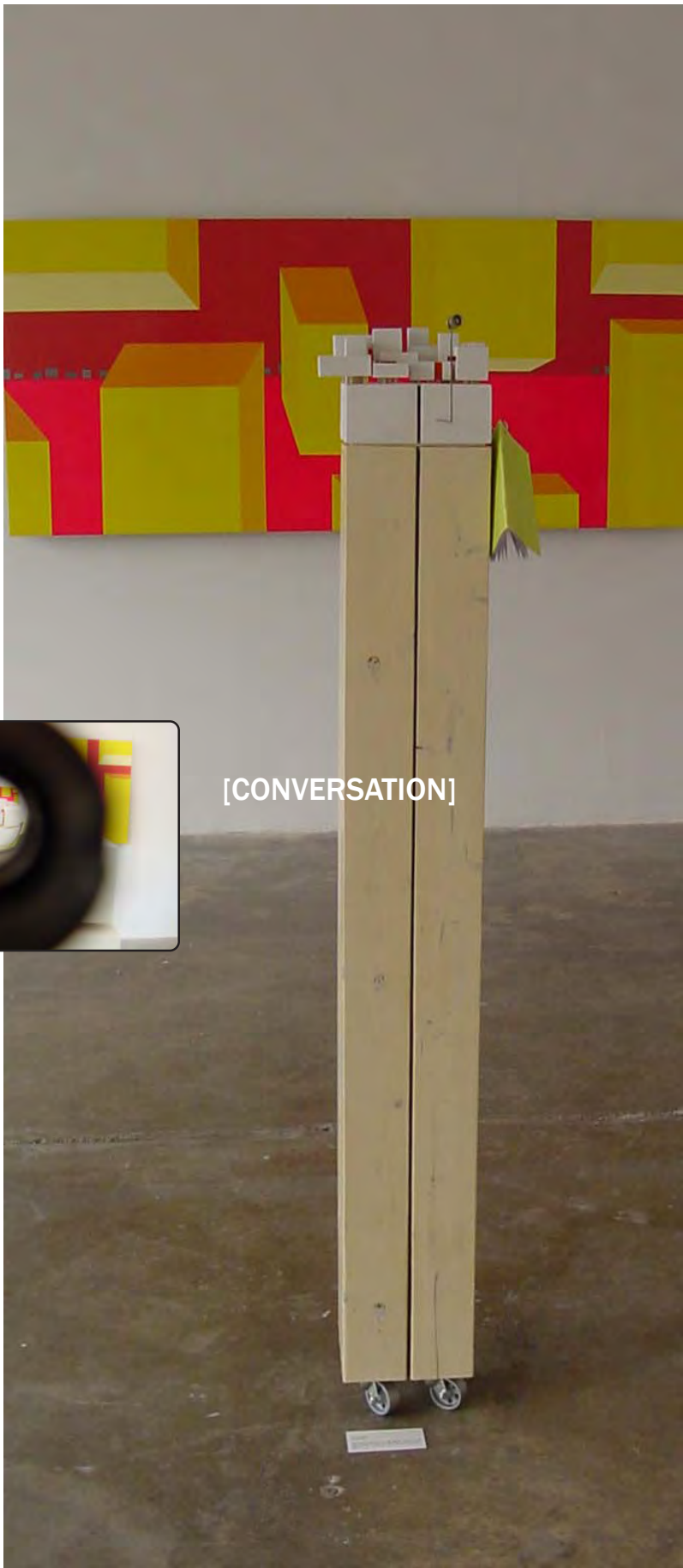

[CONVERSATION]

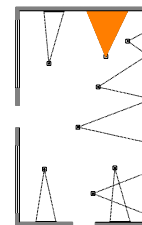

The ritual of conversation is foundational to communication. Grouped interaction begins with the collection. A series of varied volumes create a field of individuated elements. Subtracted volumes, implied by cuts into the larger volumes, suggest a secondary overlapping field: an undertone and interface. The three-dimensional field extends into the two-dimensional field with varied perspectival vanishing points: the associated groupings lead to different conclusions.

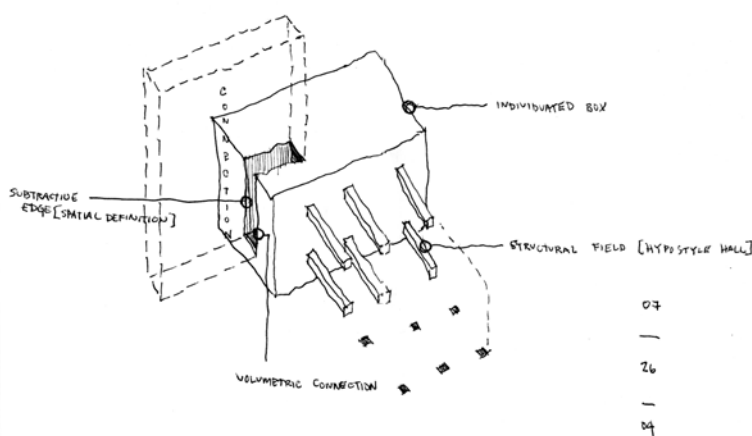



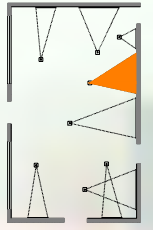

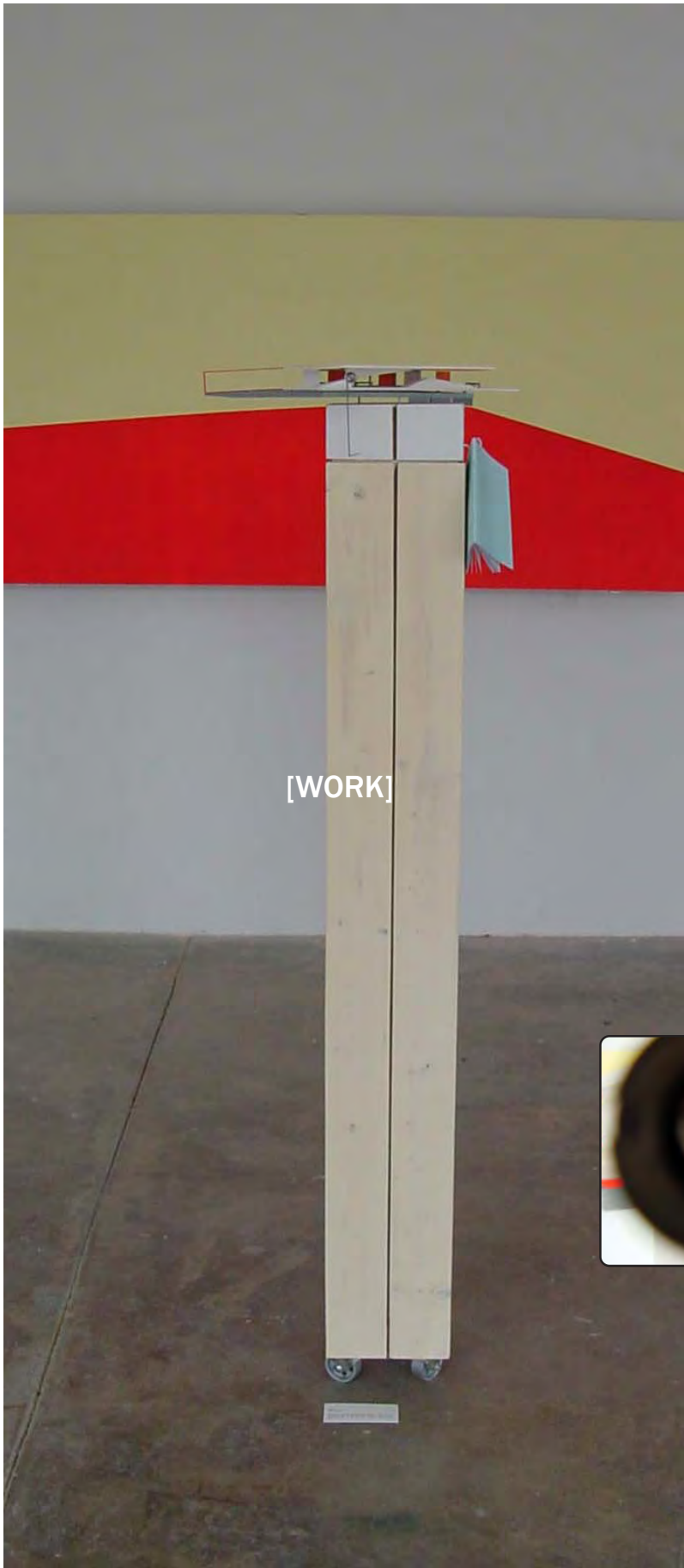

[WORK]



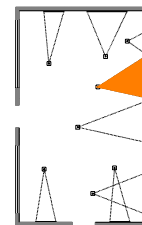

The suggestion of work is articulated through the compaction of its surroundings. Two extended horizontal planes establish an expansive spatial slice. Bulges in their surface pinch the sandwiched zone between. Floating vertical walls subdivide and crop the panorama, while a series of layered receding frames establish a foreground, middle ground, and background through their telescoping alignment. A series of framed parallelepipeds oriented to the X, Y, and Z axis correlate to the three chambers and their associated three gradients of grey located on the horizon. Each frame serves as a table - a space for work.

* 1 FIELD WORK

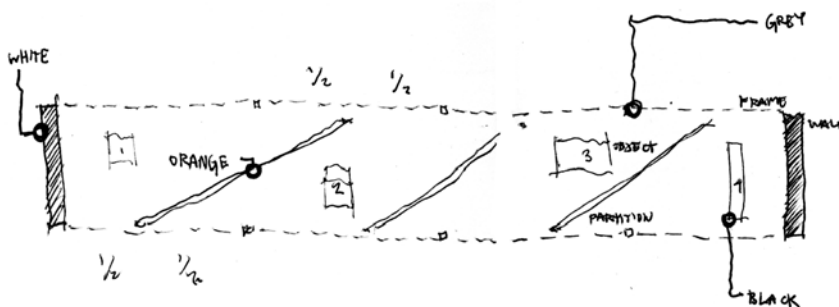

- 1 PROJECT
- 1 PLACE
- 1 STAGE

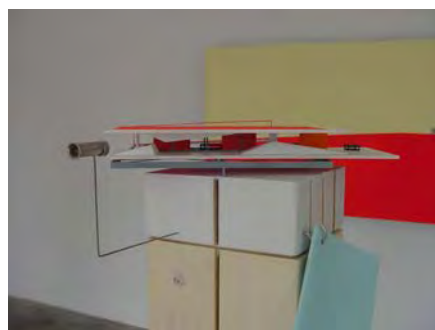



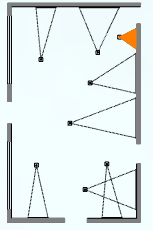



[STORE]



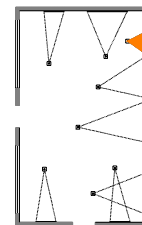

The case as a container suggests something discreet and sacred on its interior. A clustered field of diverse cases balances a larger case. Highlighted from within the field, the larger case is represented in both two and three dimensions. Voids, varying in quantity, suggest an inner removal. The edge of the three dimensional case defines an edge to the ground plane in the two-dimensional field.

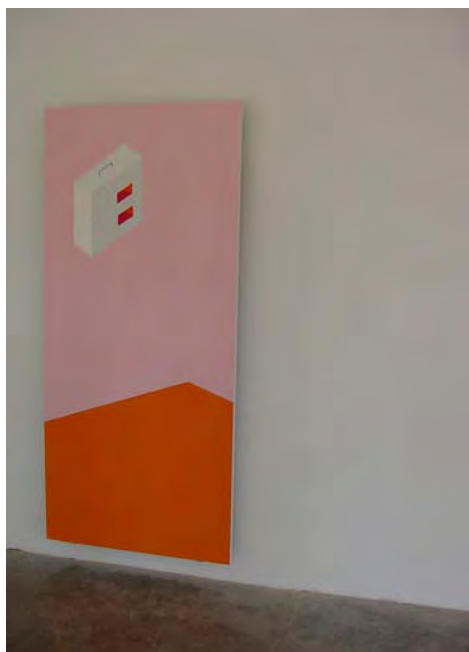
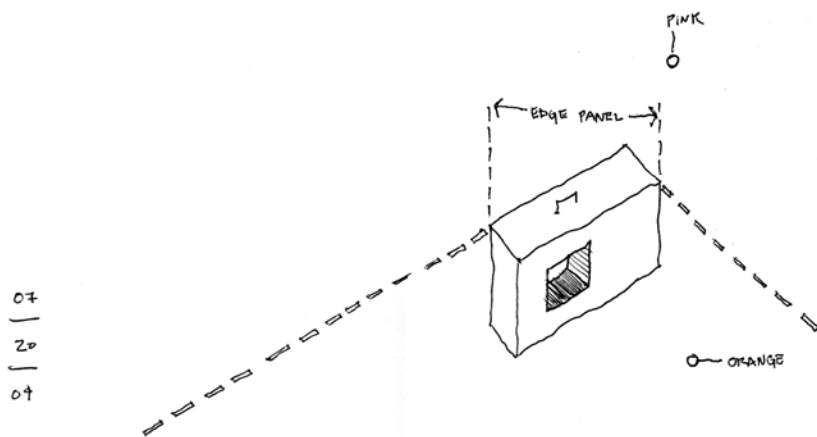





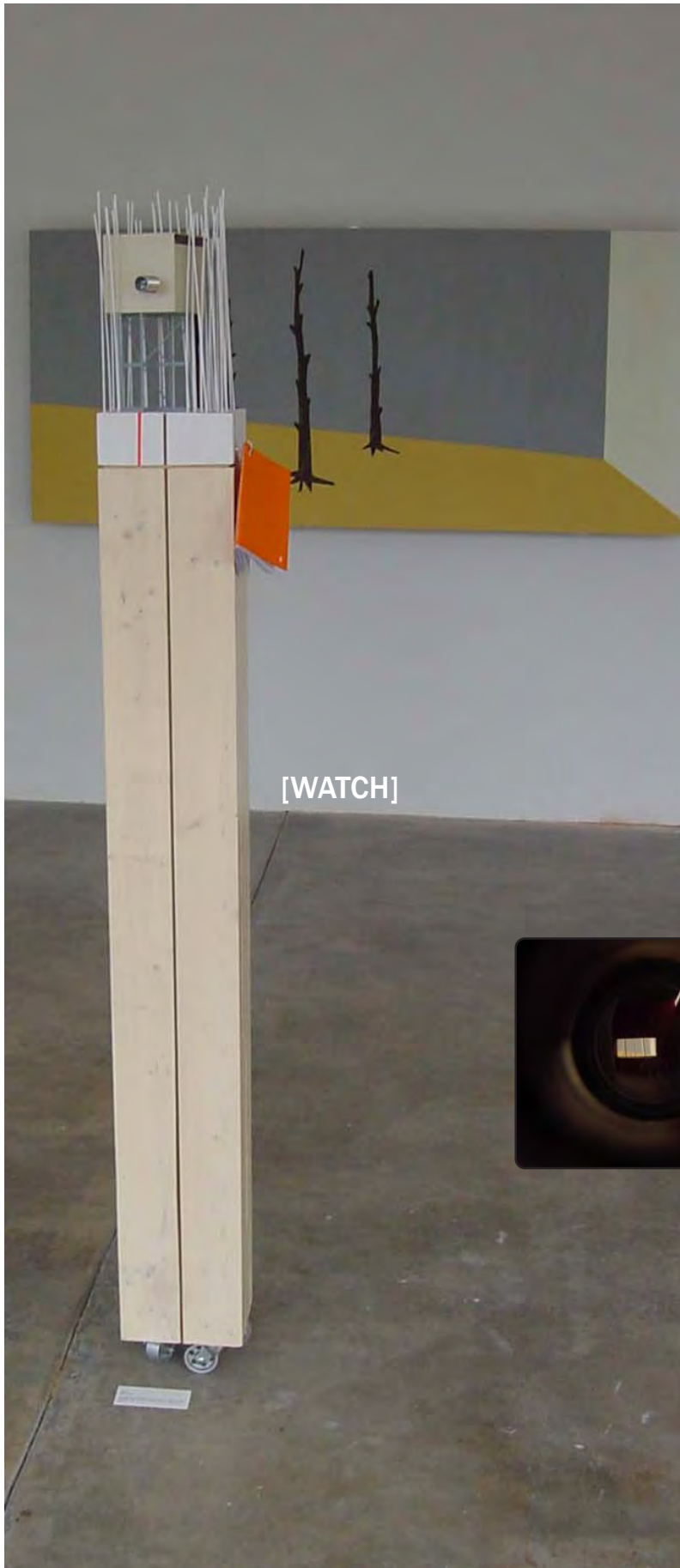

[WATCH]



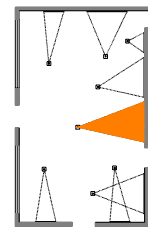

The spaceframe specifically focused on watching layers the object in space with the object in field upon the object in frame. An elevated box contains an organic form tucked to the left of view. A clerestory window bounces light into the red-orange walled chamber. A parallelogram shaped window frames the projected landscape - tightly aligning with the painted two-dimensional back drop. The vertical field aligns with the two dimensional field: hiding, collapsing, and extending its presence.

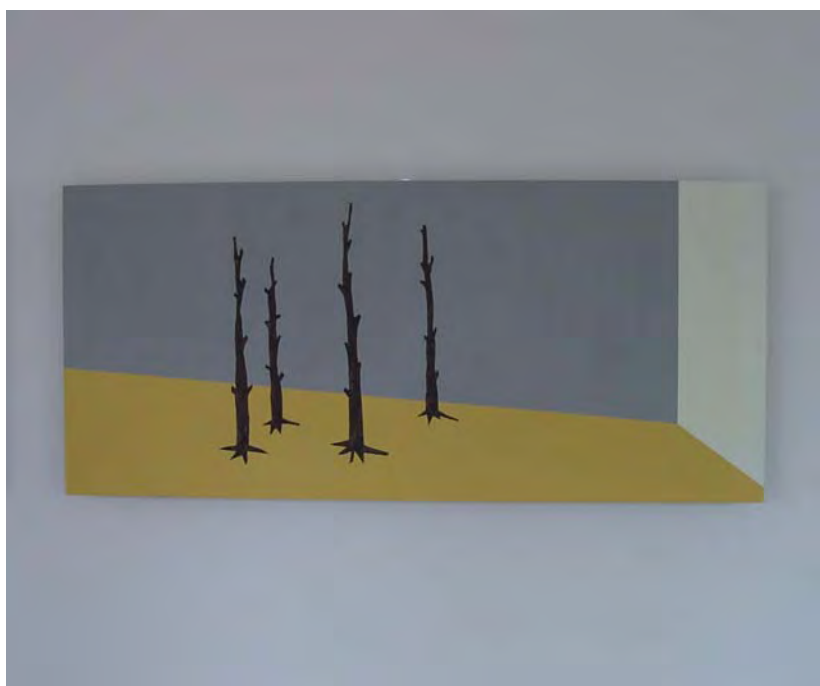
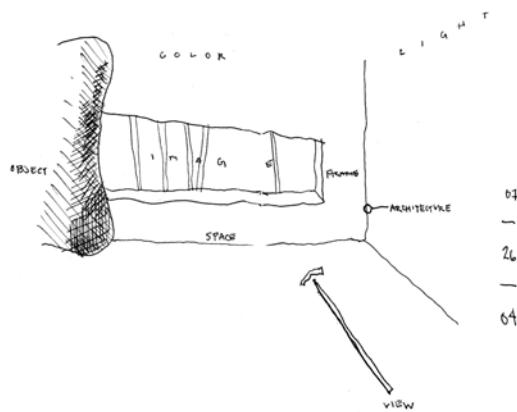

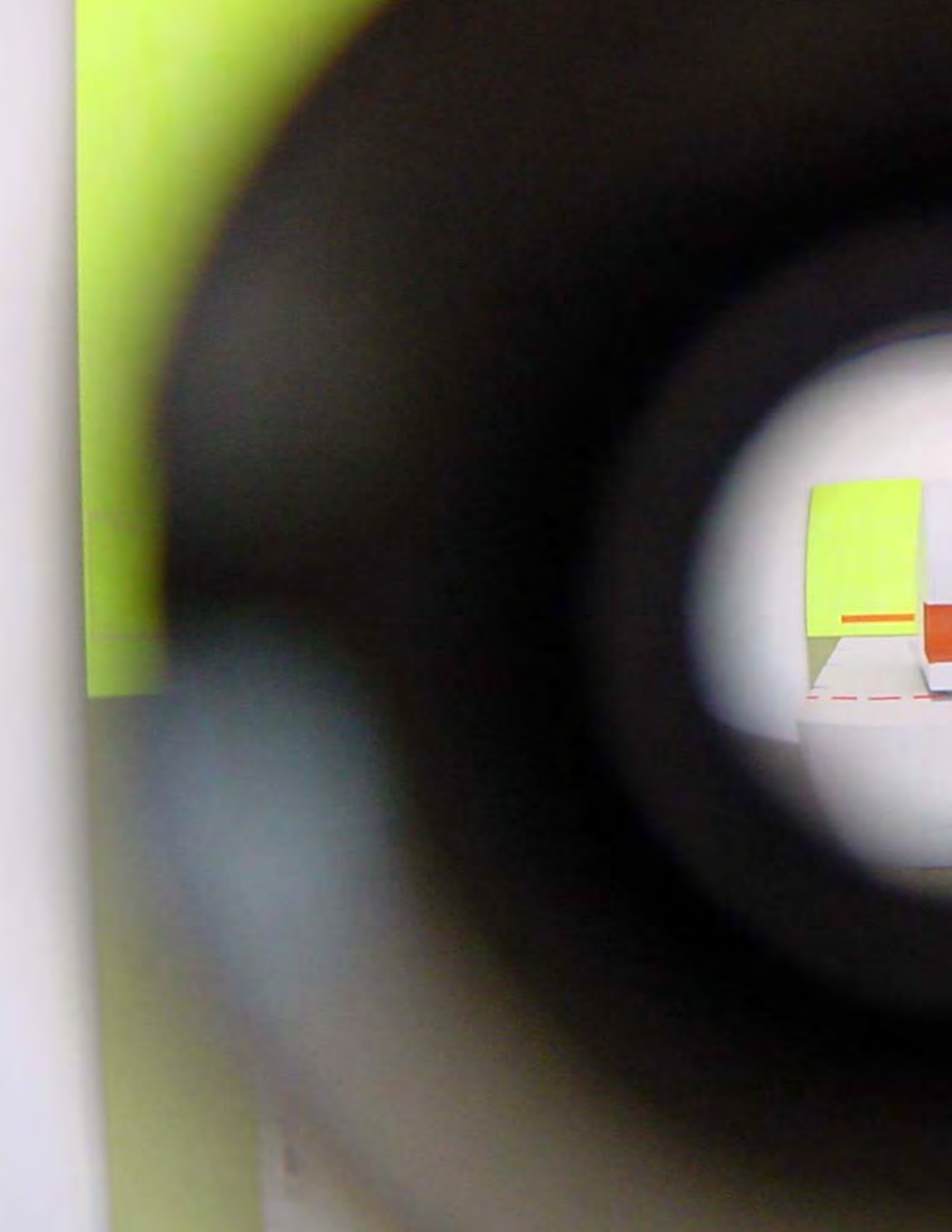

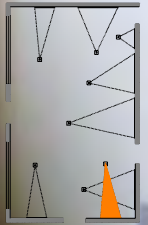



[EAT]

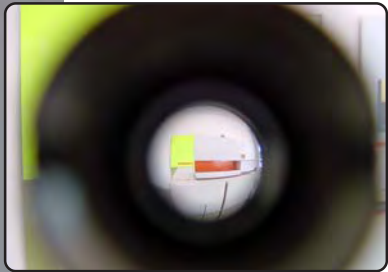

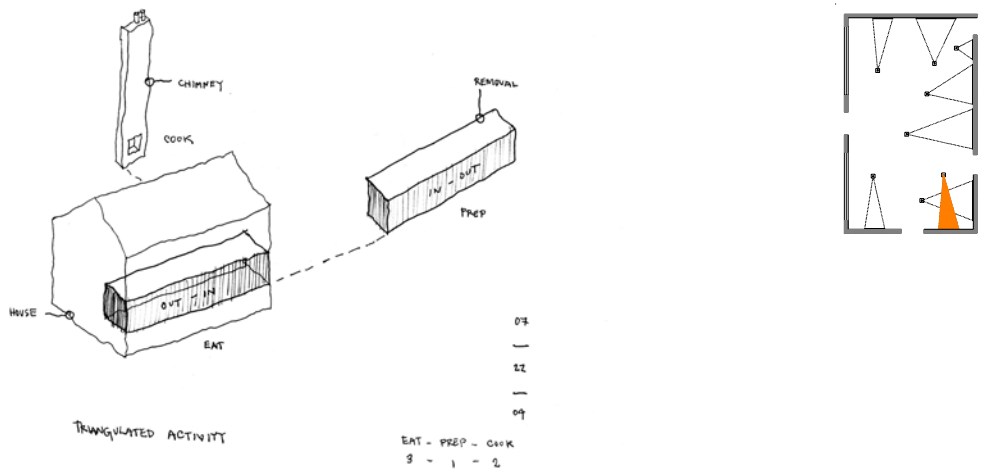

The cyclical ritual of eating is a solitary act made social through its routine. The archetypal form of the house is cut to allow a slot to slide out of the house. The result is an articulated room outside the form and a corresponding void within the form. An outdoor hearth representative of the cooking pit forms a courtyard. A projected slide out of the house in the opposing direction is held on the picture plane behind.

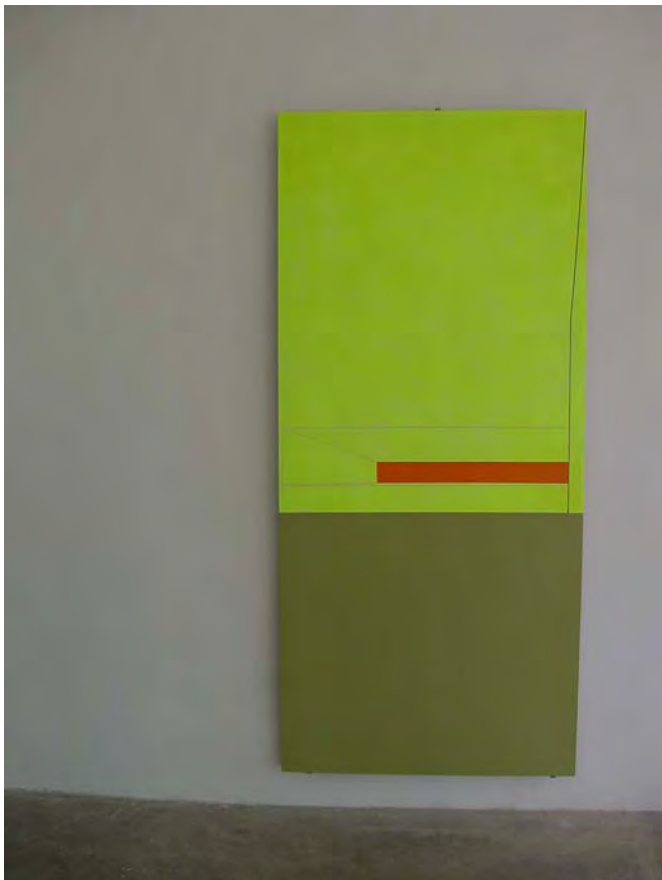



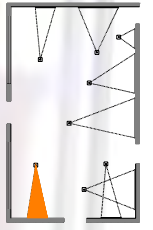



[BATHE]

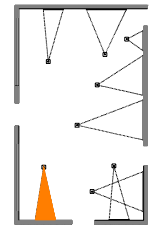

A cruciform shape provides a four branched room: one for entry, one for a toilet, one for a sink, and one for a bath. Each opening frames a varied cardinal view. The curvature of the lens causes the ceiling to present itself as a barrel vault. An outdoor cistern framed by a two dimensional projected portal aligned with the wall planes balances the interior plunge pool.

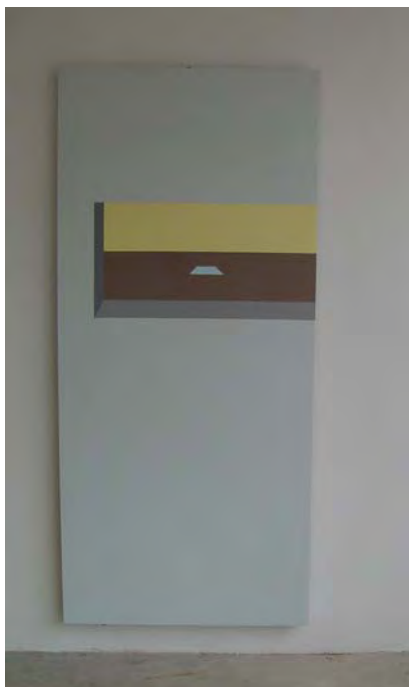
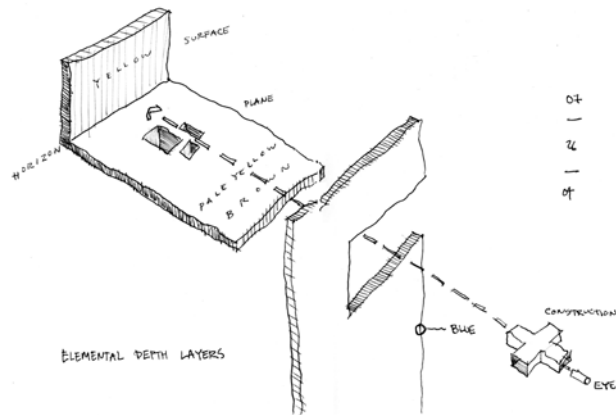

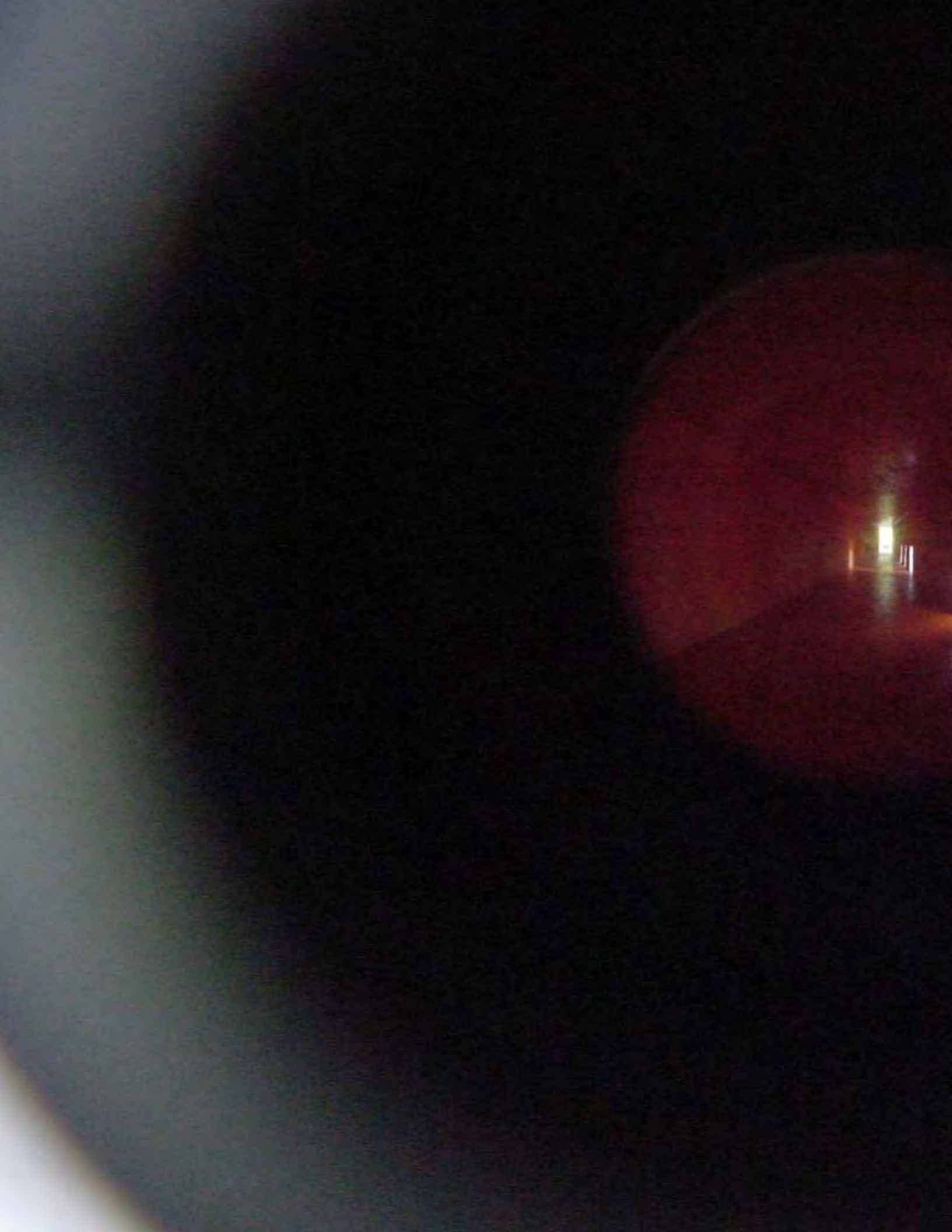

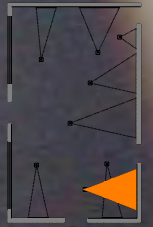

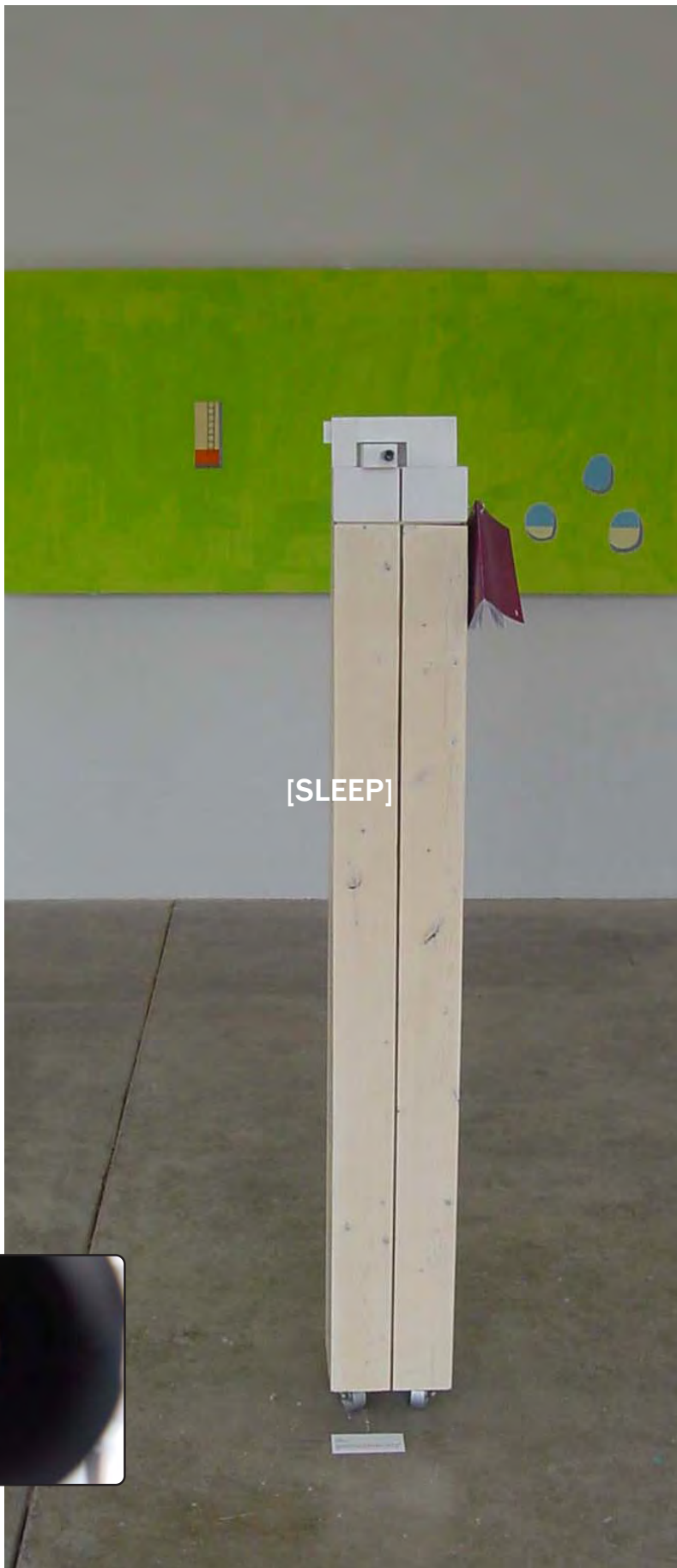

[SLEEP]

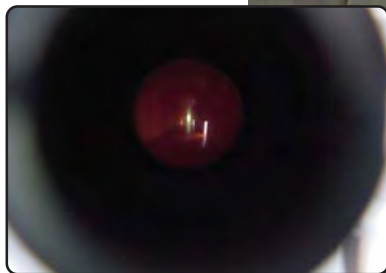

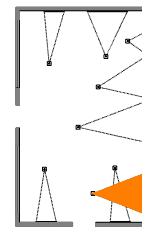

The sleep spaceframe takes the typical three bedroom formula of the single family house and articulates each room as a discrete chamber. The unique form of each cell either bridges, sets, or lays upon a funneling corridor. They are each accessed through a ladder located on a neon red-orange circle. A central corridor [with titled walls to accelerate the perspective] contains a series of openings leading to each of the three room ladders. Framed at the end of the corridor is a fourth projected ladder for ascension to the subconscious. Three additional picture plane portals suggest a “behind” to the picture plane: an alternative projection representing a diversity of realities or “dream worlds” found through slumber.

